



Izerwaren
Order
numbers

- 316 Stainless steel pulls with or without thrust roses
- Specify finish:
 - SS satin stainless steel
 - PS polished stainless steel
 - LTF Life Time Finish Gold color
 - LTF Life Time Finish Brass color
 - (LTF limited available)

Door pulls
25 mm diameter; 1"

INSTALLATION:

- For front mounting with M10 bushings
- or
- For back mounting with M10 bolts without thrust roses
- or
- For back mounting with M10 bolts with thrust roses
- or
- Back to back mounting with M10 bolts with bush without thrust roses
- or
- Back to back mounting with M10 bolts with bush without thrust roses
- or
- Glass mounting with thrust roses
- or
- Glass mounting without thrust roses

Ø x length x width (center to center)		
15.253	25Ø x 70 x 300 mm	straight pull
15.256	25Ø x 70 x 650 mm	straight pull
15.258	25Ø x 70 x 95 x 300	cranked offset
15.231	25Ø x 70 x 95 x 650	cranked offset

15.030 **Thrust-roses:** 30 mm x 2 mm
 15.019 **Thrust-roses:** 19 mm x 2 mm



Shown small and big thrust roses



15.010 Back mounting with M8 st.st. bolt
 15.00G M10 x 90 mm bolts stainless steel
 15.01T Fittings for glass to glass
 15.01T Back to back through bolts M10 st. st.



Door pull #15.253



#Door Pull #15.256



Cranked offset pull # 15.258

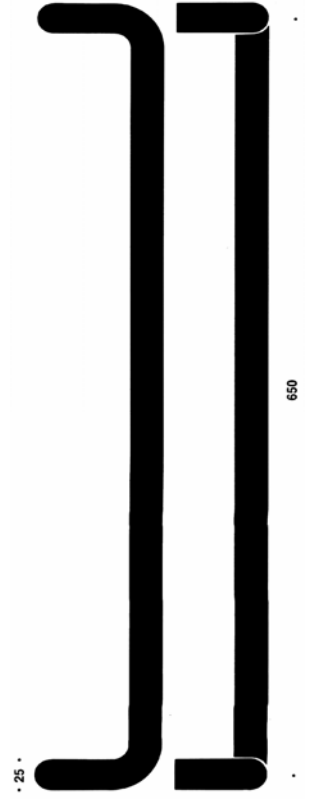

Cranked offset pull # 15.231

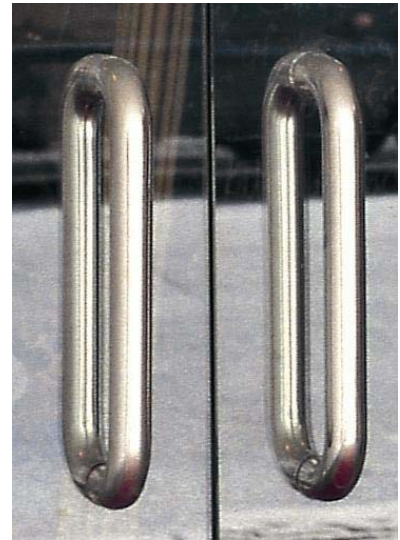

Pull # 15.930 25 x 70 x 300 mm
Mounted through glass using glass fittings #15.00G and through bolts #15.010



Cranked offset pull #15.258; 25Ø x 70 x 300 mm

SPECIFY DOORTHICKNESS!



Izerwaren
Order
numbers

- 316 Stainless steel pulls with or without thrust roses
- Specify finish:
 - SS satin stainless steel
 - PS polished stainless steel
 - LTF Life Time Finish Gold color
 - LTF Life Time Finish Brass color
 - (LTF limited available)

Door pulls 32 mm diameter; 1 1/4"

INSTALLATION:

For front mounting with M12 bolts with roses with concealed fixings

For front mounting with M10 bushings
For back mounting with M12 bolts without thrust roses

For back mounting with M12 bolts with thrust roses

Back to back mounting with M12 bolts with bush without thrust roses

Back to back mounting with M12 bolts with bush without thrust roses

Glass mounting with thrust roses

Glass mounting without thrust roses

Ø x length x width (center to center)

- 15.323 32Ø x 80 x 300 mm straight Grabrail
- 15.326 32Ø x 80 x 650 mm straight Grabrail
- 15.329 32Ø x 80 x 110 x 300 cranked offset
- 15.325 32Ø x 80 x 110 x 650 cranked offset

15.963 **Thrust-roses:** 76 mm for grabrail

15.050 **Thrust-roses:** 50 mm x 2 mm

15.080 **Thrust-roses:** 80 mm x 4 mm

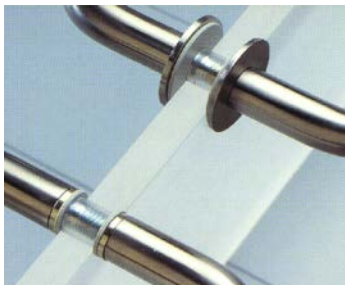

Shown small and big thrust roses

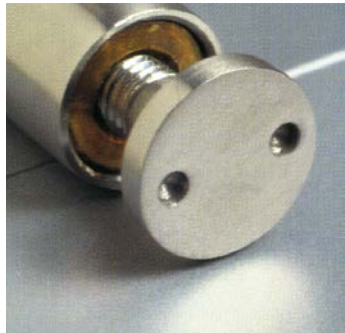

Back mounting with M12 st.st.bolt

- 15.012
- 15.00G
- 15.02T

M12 x 90 mm bolts stainless steel
Fittings for glass to glass
Back to back through bolts M12 st. st.

SPECIFY DOORTHICKNESS!



Door pull #15.323



GRABRAIL with THRUST ROSES

Pull #15.323 32Ø x 85 x 300 mm; roses #15.963; 76 mm Ø
FOR CONCEALED FRONT MOUNTING OR BACK MOUNTING

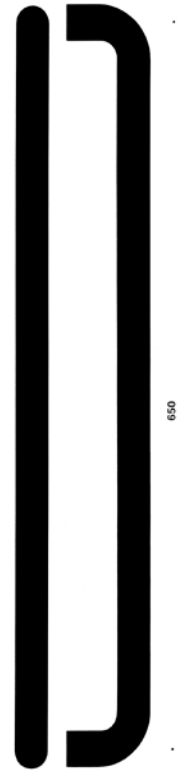

Door Pull #15.326

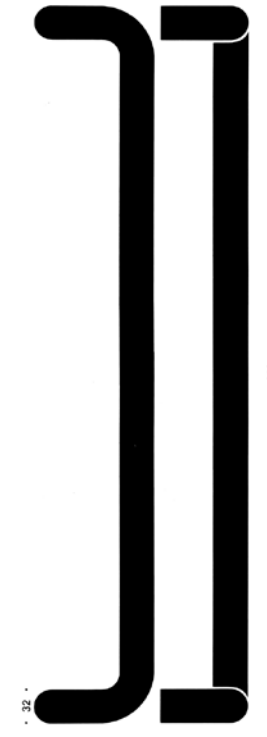

Cranked offset pull # 15.325;
32Ø x 80 x 110 x 650 mm



Cranked offset pull #15.329;
32Øx 80 x 110 x 300 mm
back mounted with M12 bolt



Cranked offset Pull #15.329

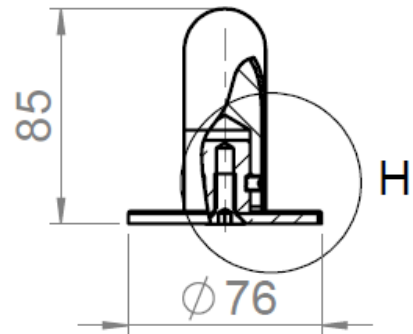
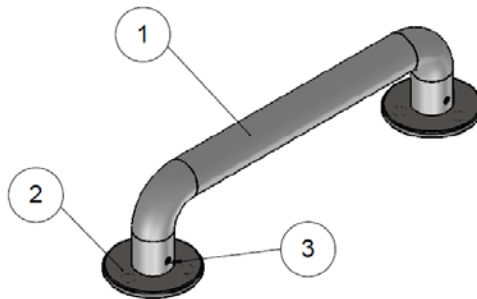
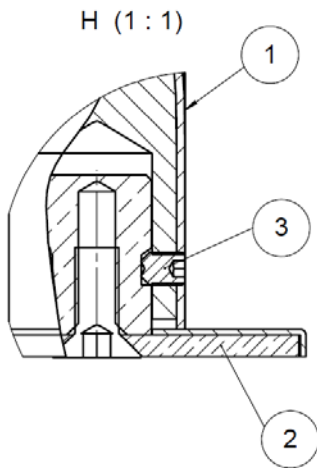
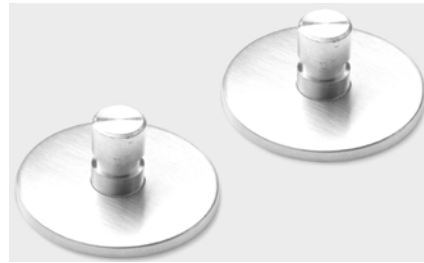
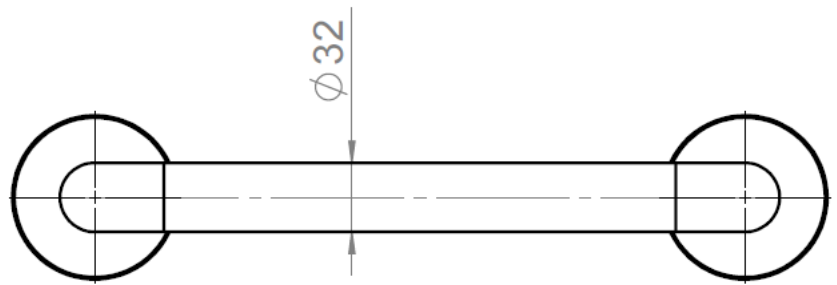
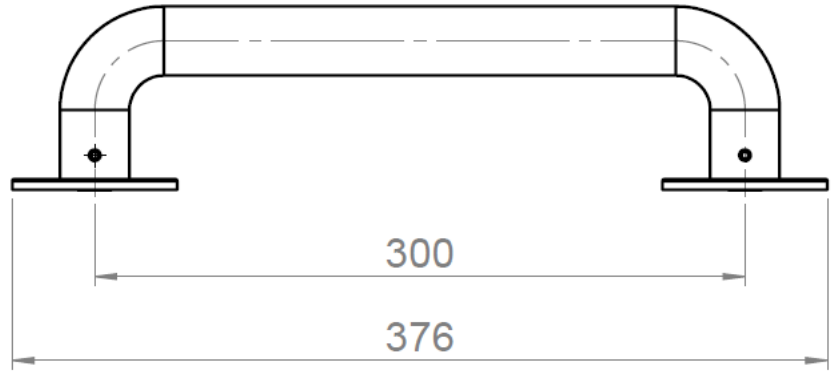

#15.323 Grab Bar / Deck Step Hand Pull. 32 mm / 1 1/4 inch diameter
#15.963 Thrust roses 80 mm / 3 1/8 inch diameter

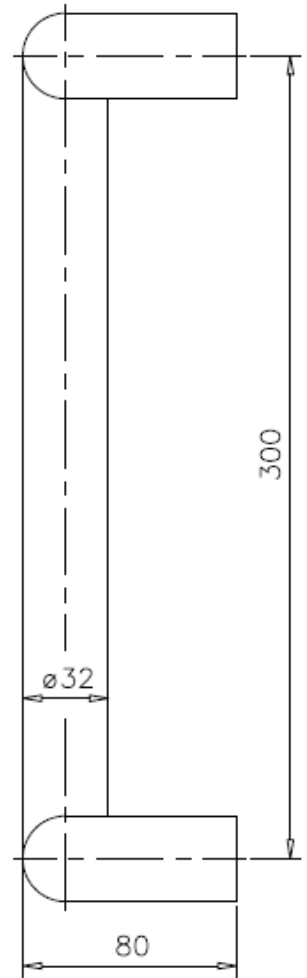
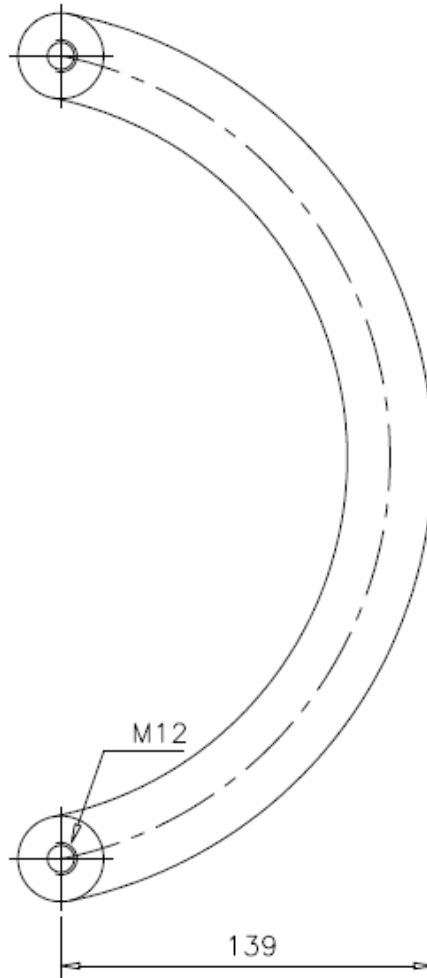

#16.303 Circular Pull # 32 mm diameter x 300 mm M12 threaded for back mounting

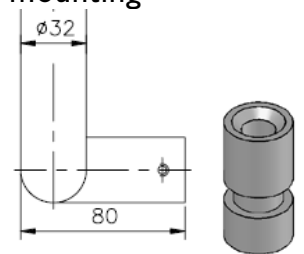
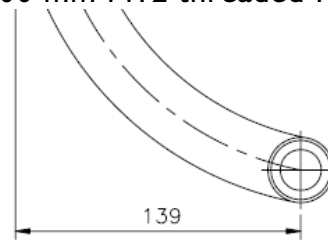

#16.3032 Circular Pull # 32 mm diameter x 300 mm with 20 mm diameter hole for bushing for front mounting

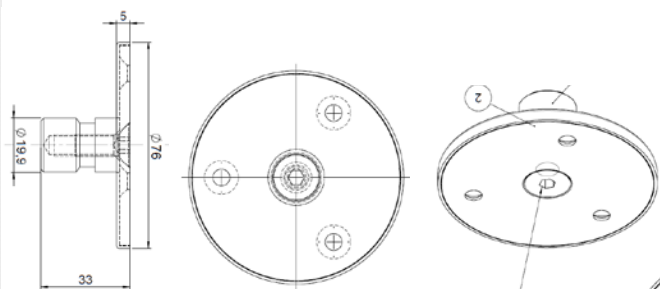

#15.963 Thrust rose 76 mm, 5 mm thick with st.st cover plate

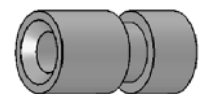

#15.4950 Bushing 19.5 mm



Part no.
17.3000

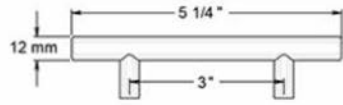

17.3750

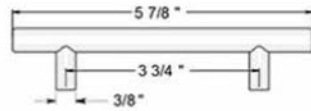

17.3500



17.5000

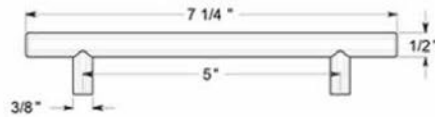

17.7500

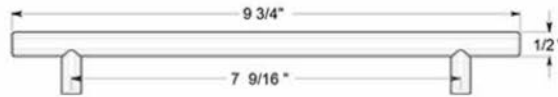

17.1000

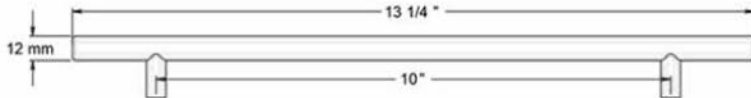

17.1138

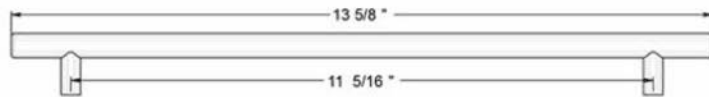

17.1250

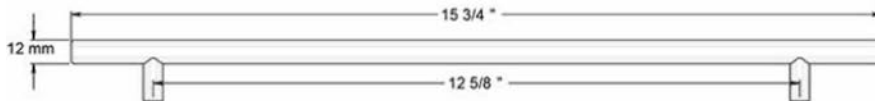

- 17.3000** Cabinet pull 5.25 inch long CC 3 inch 12 mm diameter each
- 17.3001** Cabinet pull 5.25 inch long CC 3 inch 12 mm diameter each
- 17.3750** Cabinet pull 6 1/8 inch long CC 3.75 inch 12 mm diameter each
- 17.3751** Cabinet pull 6 1/8 inch long CC 3.75 inch 12 mm diameter each
- 17.5000** Cabinet pull 7 3/16 inch long CC 5 inch 12 mm diameter each
- 17.5001** Cabinet pull 7 3/16 inch long CC 5 inch 12 mm diameter each
- 17.7500** Cabinet pull 9 3/4 inch long CC 7.5 inch 12 mm diameter each
- 17.7501** Cabinet pull 9 3/4 inch long CC 7.5 inch 12 mm diameter each
- 17.1000** Cabinet pull 13 1/3 inch long CC 10 inch 12 mm diameter each
- 17.1001** Cabinet pull 13 1/3 inch long CC 10 inch 12 mm diameter each
- 17.1138** Cabinet pull 13.58 inch long CC 11.375 inch 12 mm diameter each
- 17.11381** Cabinet pull 13.58 inch long CC 11.375 inch 12 mm diameter each
- 17.1250** Cabinet pull 15 inch long CC 12.5 inch 12 mm diameter each
- 17.1251** Cabinet pull 15 inch long CC 12.5 inch 12 mm diameter each



17.1378

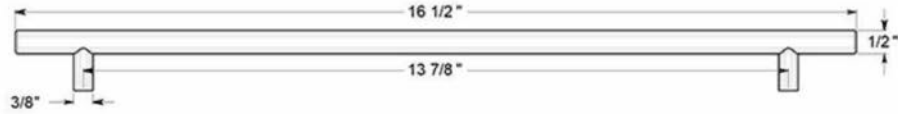

17.1638

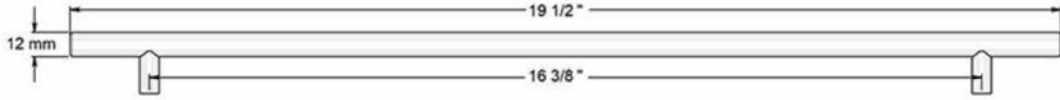

17.1900

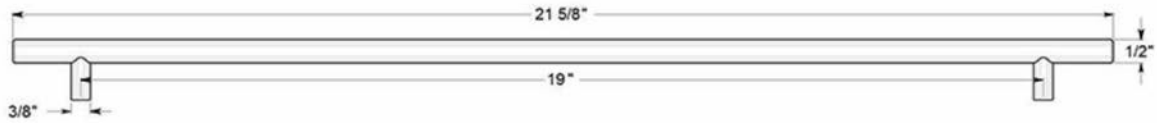

17.1878

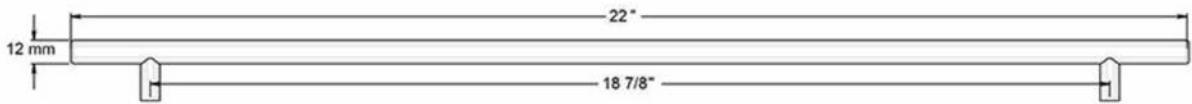

17.2138

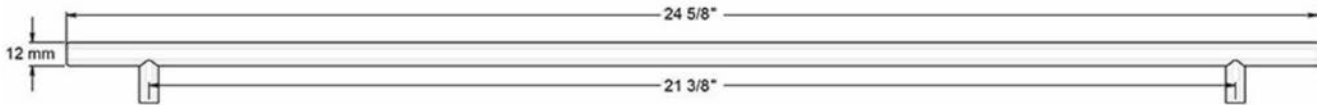

Pulls of solid stainless steel with M3 break away through bolts

Applicazioni Applications	Eps Epoxy Coating	Galvaniche Galvanic	design Pinuccio Borgonovo	MN 1032 Z
	E1	G9		
	E2	G104		
	E9	G105		
		G171		

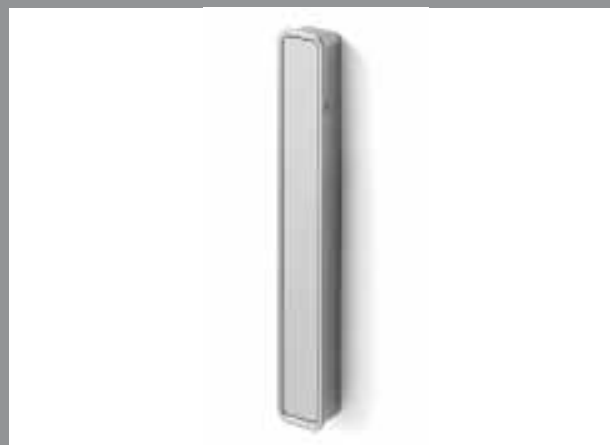

Applicazioni Applications	Eps Epoxy Coating	Galvaniche Galvanic	design Pinuccio Borgonovo	MN 1025 Z
	E1	G9		
	E2	G104		
	E9	G105		
		G171		



Applicazioni Applications	Eps Epoxy Coating	Galvaniche Galvanic	MN 1034 Z
	E1	G104	
	E2	G105	
	E9	G115	



Applicazioni Applications	Eps Epoxy Coating	Galvaniche Galvanic	MN 1018 Z
	E1	G104	
	E2	G105	
	E9	G115	



Applicazioni Applications	Eps Epoxy Coating	Galvaniche Galvanic
	E1	
	E2	
	E4	
	E9	

design **MN 768 Z**
Marelli e Molteni

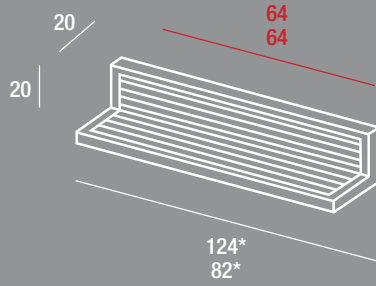

Applicazioni Applications	Eps Epoxy Coating	Galvaniche Galvanic
	E1	G171
	E2	G9
	E9	

design **MN 968 Z**
G. Bavuso

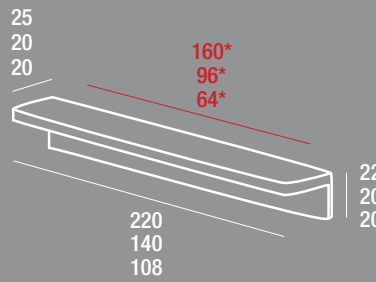

Applicazioni Applications	Eps Epoxy Coating	Galvaniche Galvanic
	E10	
	E11	

design **MN 810 I**
G. Bavuso

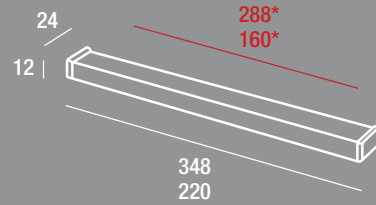

misure su richiesta size on request

Applicazioni Applications	Eps Epoxy Coating	Galvaniche Galvanic
L1	E10	
L2	E11	

design **MN 811 I**
G. Bavuso

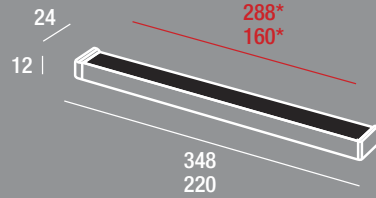

misure su richiesta size on request

Applicazioni Applications	Eps Epoxy Coating	Galvaniche Galvanic
	E1	G9
	E2	G104
	E9	G115

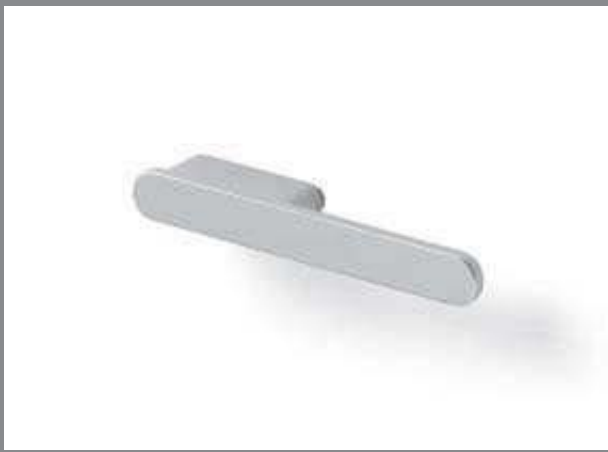
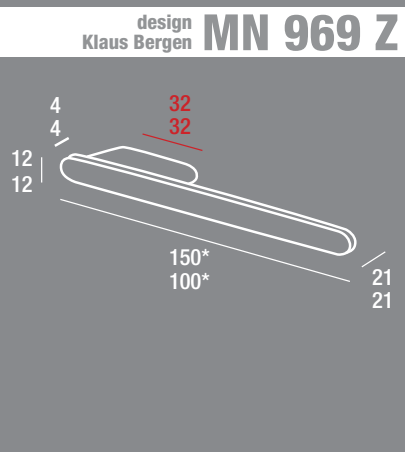

Applicazioni Applications	Eps Epoxy Coating	Galvaniche Galvanic
E10	E10	G115
E11	E11	
X1		
I1		

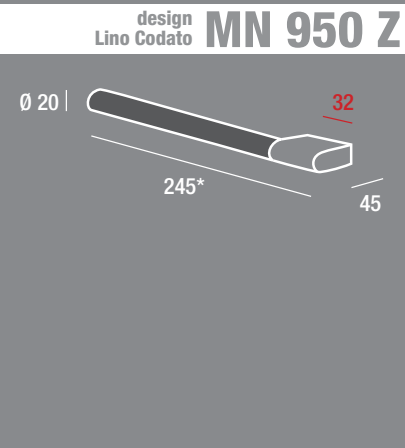

Applicazioni Applications	Eps Epoxy Coating	Galvaniche Galvanic
	E1	G9
	E2	G104
	E9	G115

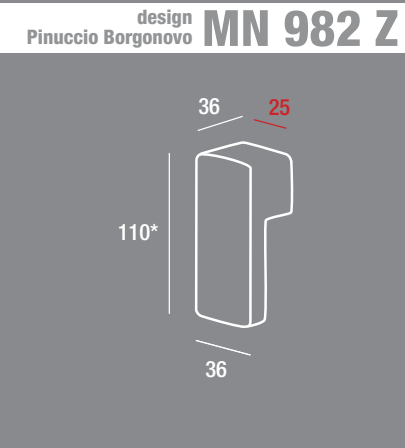

Applicazioni Applications	Eps Epoxy Coating	Galvaniche Galvanic
	E1	G9
	E2	G104
	E4	G115
	E9	

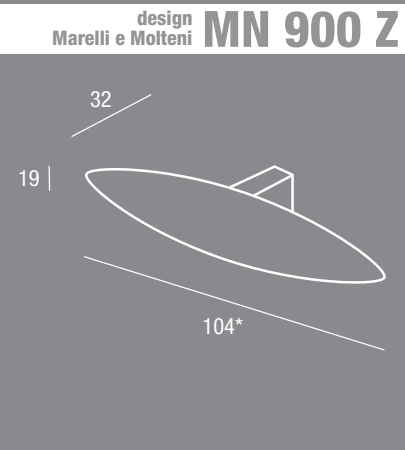



MN 1005 Z design Giuseppe Bavuso

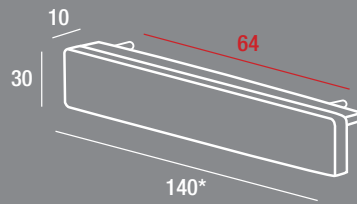

Galvaniche <i>Galvanic</i>	Eps <i>Epoxy Coating</i>	Applicazioni <i>Applications</i>
G9	E1	
G115	E2	
	E9	



MN 1006 Z design Giuseppe Bavuso

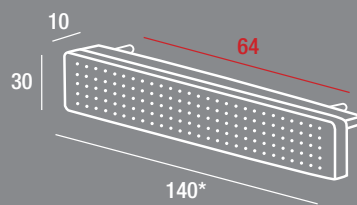

Galvaniche <i>Galvanic</i>	Eps <i>Epoxy Coating</i>	Applicazioni <i>Applications</i>
G9	E1	
G115	E2	
	E9	



MN 1003 Z design Giuseppe Bavuso

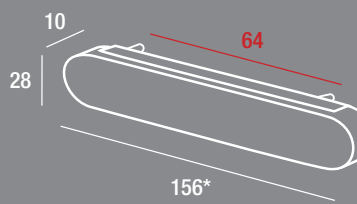

Galvaniche <i>Galvanic</i>	Eps <i>Epoxy Coating</i>	Applicazioni <i>Applications</i>
G9	E1	
G115	E2	
	E9	



MN 1004 Z design Giuseppe Bavuso

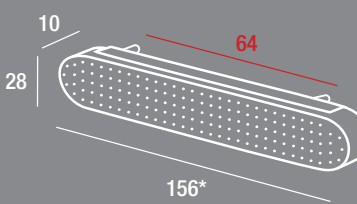

Galvaniche <i>Galvanic</i>	Eps <i>Epoxy Coating</i>	Applicazioni <i>Applications</i>
G9	E1	
G115	E2	
	E9	

Applicazioni Applications	Eps Epoxy Coating	Galvaniche Galvanic
	E10	I1
	E11	

design **MN 946 I**
Lino Codato

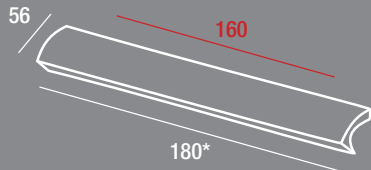

misure su richiesta size on request



Applicazioni Applications	Eps Epoxy Coating	Galvaniche Galvanic
	E1	G104
	E2	G115
	E4	G140
	E9	
	I1	

MN 640 Z/I

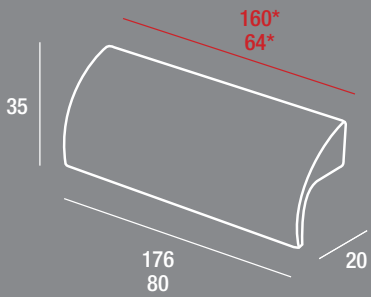

misure su richiesta size on request



Applicazioni Applications	Eps Epoxy Coating	Galvaniche Galvanic
	E1	G104
	E2	G150
	E4	
	E9	

MN 824 Z

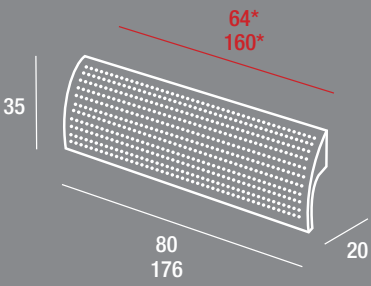

misure su richiesta size on request

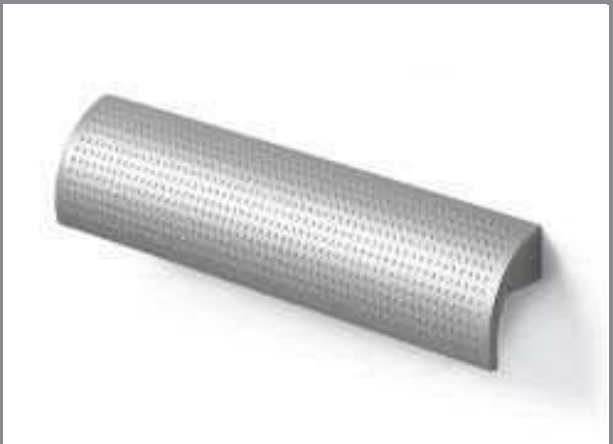

Applicazioni Applications	Eps Epoxy Coating	Galvaniche Galvanic
		A13

MN 824 A

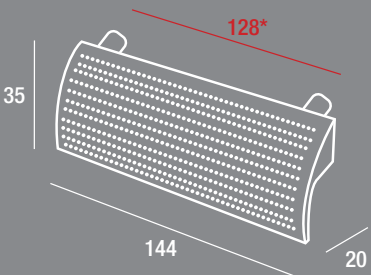

misure su richiesta size on request

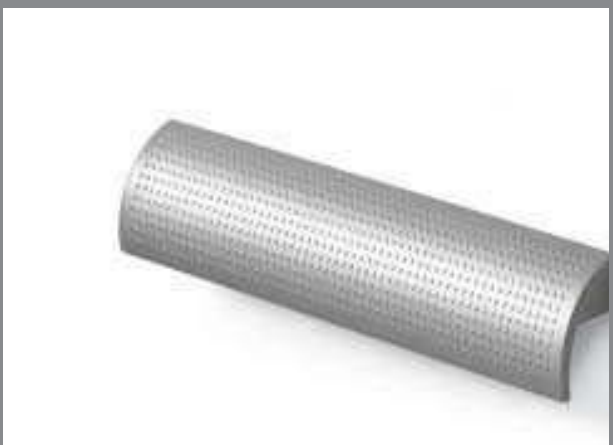

Applicazioni Applications	Eps Epoxy Coating	Galvaniche Galvanic
	E1	G9
	E2	G104
	E4	G115
	E9	

design **MN 868 Z**
Giuseppe Bavuso

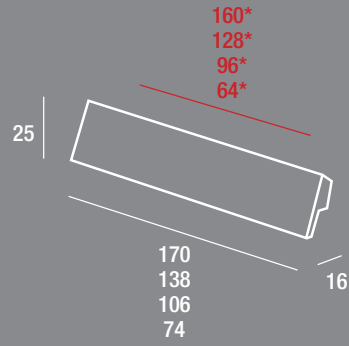

Applicazioni Applications	Eps Epoxy Coating	Galvaniche Galvanic
	E1	G9
	E2	G115
	E4	
	E9	

MN 788 Z

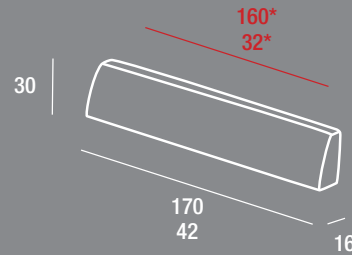

Applicazioni Applications	Eps Epoxy Coating	Galvaniche Galvanic
	E1	G9
	E2	G104
	E4	G115
	E9	

design **MN 861 Z**
Giuseppe Bavuso

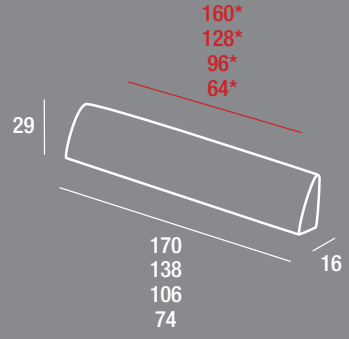

Applicazioni Applications	Eps Epoxy Coating	Galvaniche Galvanic
	E10	
	E11	

design **MN 862 Z**
Giuseppe Bavuso

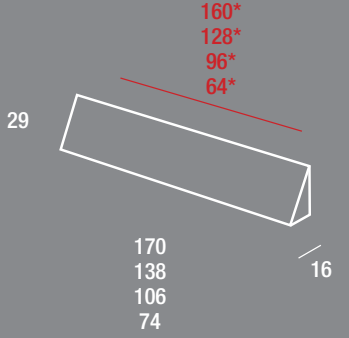

misure su richiesta size on request



MN 865 Z design Ettore Tinagli

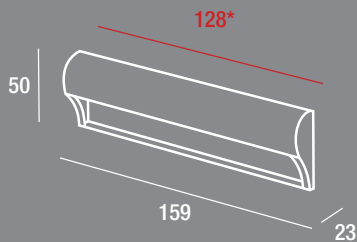

Galvaniche Galvanic	Eps Epoxy Coating	Applicazioni Applications
G104	E1	
G115	E2	
G150	E4	
	E9	



MN 752 Z design Luigi Vaghi

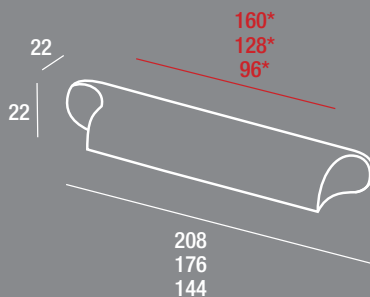

Galvaniche Galvanic	Eps Epoxy Coating	Applicazioni Applications
G104	E1	
G115	E2	
G140	E4	
	E9	



MN 582 Z

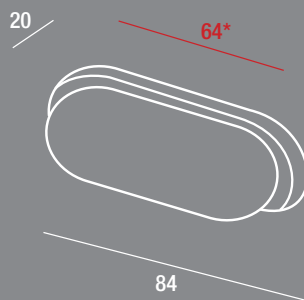

Galvaniche Galvanic	Eps Epoxy Coating	Applicazioni Applications
G101	E1	
G102	E2	
G104	E4	
G107	E9	
G113		
G115		
G140		



MN 586 Z

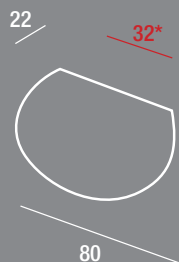

Galvaniche Galvanic	Eps Epoxy Coating	Applicazioni Applications
G104	E1	
G115	E2	
G140	E4	
	E9	

Applicazioni Applications	Eps Epoxy Coating	Galvaniche Galvanic
	E1	G104
	E2	G107
	E4	G115
	E9	G140

MN 701 Z

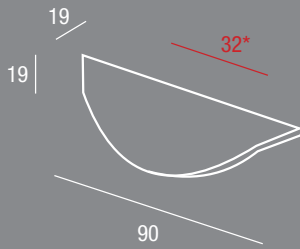

Applicazioni Applications	Eps Epoxy Coating	Galvaniche Galvanic
	E1	G104
	E2	G115
	E4	G140
	E9	

design G. Bavuso MN 687 Z

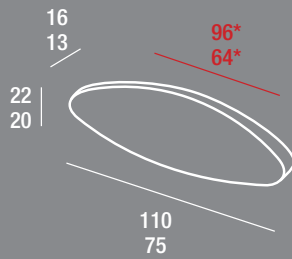

Applicazioni Applications	Eps Epoxy Coating	Galvaniche Galvanic
	E1	G104
	E2	G107
	E4	G115
	E9	G140

MN 408 Z



Applicazioni Applications	Eps Epoxy Coating	Galvaniche Galvanic
U1	E1	G104
	E2	G115
	E4	G140
	E9	

MN 395 Z





MN 808 Z design Giuseppe Bavuso

Galvaniche Galvanic	Eps Epoxy Coating	Applicazioni Applications
G104	E1	
G150	E2	
G171	E9	



MN 807 Z design Giuseppe Bavuso

Galvaniche Galvanic	Eps Epoxy Coating	Applicazioni Applications
G104	E1	
G150	E2	
G171	E9	



MN 814 Z design Giuseppe Bavuso

Galvaniche Galvanic	Eps Epoxy Coating	Applicazioni Applications
G150	E1	
	E2	
	E9	



MN 815 Z design Giuseppe Bavuso

Galvaniche Galvanic	Eps Epoxy Coating	Applicazioni Applications
G150	E1	
	E2	
	E9	

Applicazioni Applications	Eps Epoxy Coating	Galvaniche Galvanic	design Pinuccio Borgonovo	MN 959 Z
	E1	G9		
	E2	G104		
	E9	G115		
		G171		



Applicazioni Applications	Eps Epoxy Coating	Galvaniche Galvanic	design Pinuccio Borgonovo	MN 1010 Z
	E1	G9		
	E2	G104		
	E9	G115		
		G171		



Applicazioni Applications	Eps Epoxy Coating	Galvaniche Galvanic	design Marelli e Molteni	MN 721 Z
G104	E1	G104		
G115	E2	G115		
G140	E4	G140		
E1	E9			
E2				
E4				
E9				
A10				



Applicazioni Applications	Eps Epoxy Coating	Galvaniche Galvanic	design Marelli e Molteni	MN 721 Z
G104	E1	G104		
G115	E2	G115		
G140	E4	G140		
E1	E9			
E2				
E4				
E9				
A10				



Applicazioni Applications	Eps Epoxy Coating	Galvaniche Galvanic
	E1	G9
	E2	G171
	E9	

design **MN 920 Z**
Giuseppe Bavuso

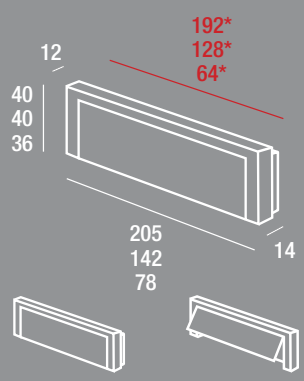

Applicazioni Applications	Eps Epoxy Coating	Galvaniche Galvanic
	E1	G9
	E2	G171
	E9	

design **MN 921 Z**
Giuseppe Bavuso

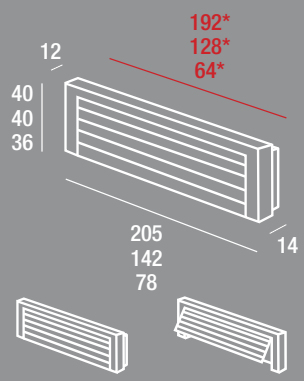

Applicazioni Applications	Eps Epoxy Coating	Galvaniche Galvanic
	E1	G9
	E2	G171
	E9	

design **MN 922 Z**
Giuseppe Bavuso

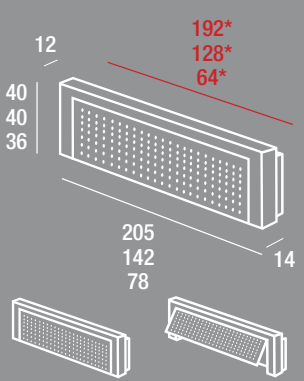

Applicazioni Applications	Eps Epoxy Coating	Galvaniche Galvanic
G115	E1	G104
G140	E2	G115
E1	E4	G140
E2	E9	
E4		
E9		

design **MN 321 Z**
Fabio Redaelli

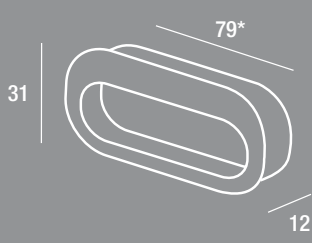



MN 295 Z

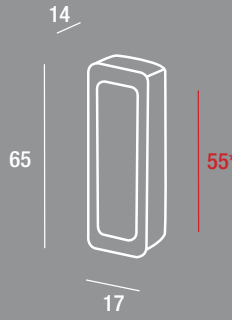

Galvaniche Galvanic	Eps Epoxy Coating	Applicazioni Applications
G104	E1	
G115	E2	
G140	E4	
	E9	



MN 503 Z

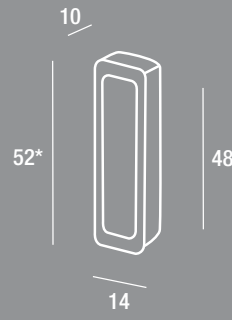

Galvaniche Galvanic	Eps Epoxy Coating	Applicazioni Applications
G104	E1	
G115	E2	
G140	E4	
	E9	



MN 918 I design Giuseppe Bavuso

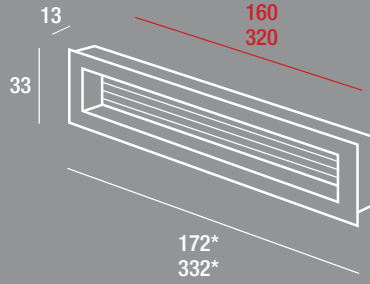

Galvaniche Galvanic	Eps Epoxy Coating	Applicazioni Applications
	E10	
	E11	



MN 852 Z design Ettore Tinagli

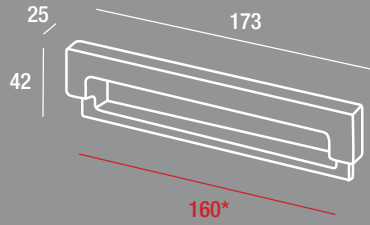

Galvaniche Galvanic	Eps Epoxy Coating	Applicazioni Applications
	E1	
	E2	
	E9	

Applicazioni Applications	Eps Epoxy Coating	Galvaniche Galvanic
	E1	G104
	E2	G115
	E4	G140
	E9	

MN 469 Z

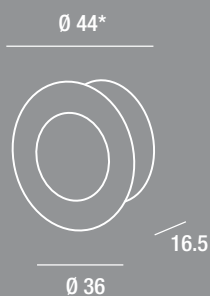

Applicazioni Applications	Eps Epoxy Coating	Galvaniche Galvanic
G9	E1	G9
G171	E2	G171
E1	E9	
E2		
E9		
L1		

design MN 897 Z Marelli e Molteni

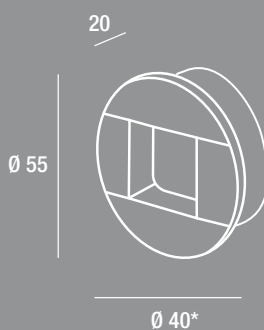

Applicazioni Applications	Eps Epoxy Coating	Galvaniche Galvanic
G9	E1	G9
G171	E2	G171
E1	E9	
E2		
E9		
L1		

design MN 898 Z Marelli e Molteni

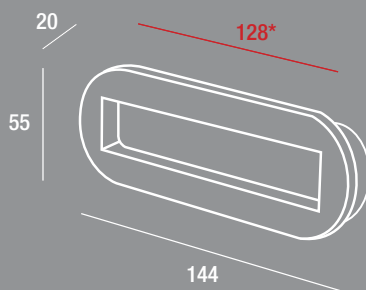

Applicazioni Applications	Eps Epoxy Coating	Galvaniche Galvanic
G104	E1	G104
G115	E2	G115
E1	E4	
E2	E9	
E4		
E9		
L1		
L2		

design MN 713 Z Marelli e Molteni

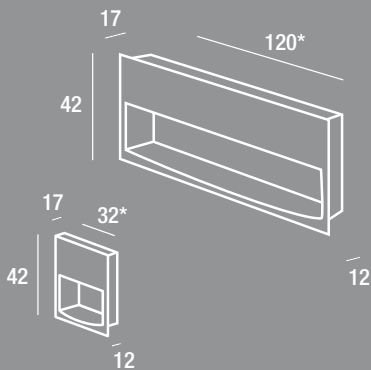



MN 729 Z design Domus e Design



Galvaniche Galvanic	Eps Epoxy Coating	Applicazioni Applications
	E1	E1
	E2	E2
	E4	E4
	E9	E9



MN 729 Z design Domus e Design



Galvaniche Galvanic	Eps Epoxy Coating	Applicazioni Applications
G104	E1	R1
G115	E2	L1
G140	E4	L2
	E9	



MN 714 Z design Riposo Design

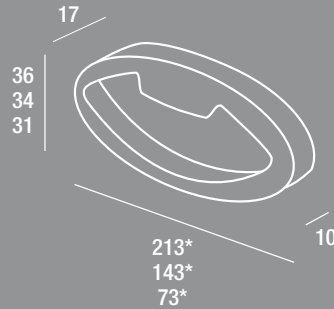

Galvaniche Galvanic	Eps Epoxy Coating	Applicazioni Applications
G104	E1	E1
G115	E2	E2
G140	E4	E4
	E9	E9
		L1
		L2



MN 714 Z design Riposo Design

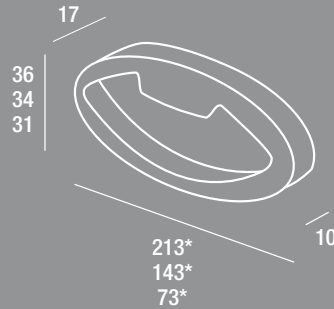

Galvaniche Galvanic	Eps Epoxy Coating	Applicazioni Applications
G104	E1	E1
G115	E2	E2
G140	E4	E4
	E9	E9
		L1
		L2

Applicazioni Applications	Eps Epoxy Coating	Galvaniche Galvanic
E1	E1	G11
E2	E2	G104
E9	E9	
G11		
G104		

design Domus e Design **MN 800 Z**

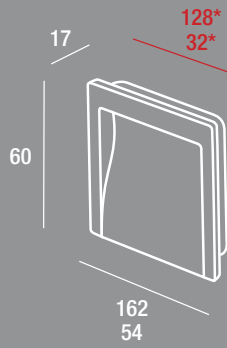

Applicazioni Applications	Eps Epoxy Coating	Galvaniche Galvanic
E1	E1	G11
E2	E2	G104
E9	E9	
G11		
G104		

design Domus e Design **MN 800 Z**

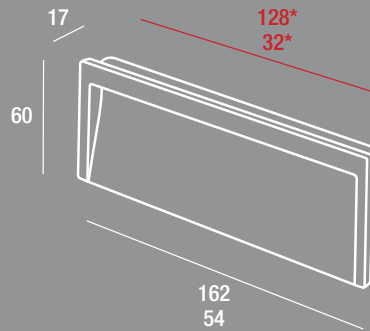

Applicazioni Applications	Eps Epoxy Coating	Galvaniche Galvanic
E1	E1	
E2	E2	
E9	E9	

design Giuseppe Bavuso **MN 802 Z**

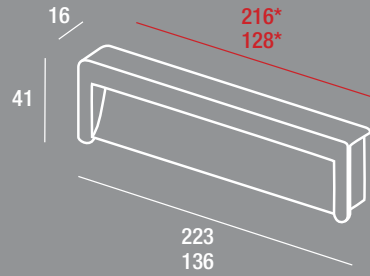

Applicazioni Applications	Eps Epoxy Coating	Galvaniche Galvanic
E1	E1	
E2	E2	
E9	E9	

design Giuseppe Bavuso **MN 802 Z**

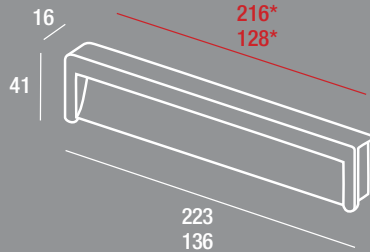

Applicazioni Applications	Eps Epoxy Coating	Galvaniche Galvanic
E1	E1	G9
E2	E2	G104
E9	E9	G171
G9		
G104		
G171		

MN 926 Z

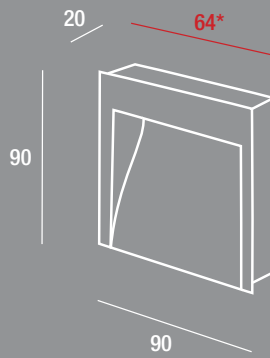

Applicazioni Applications	Eps Epoxy Coating	Galvaniche Galvanic
E1	E1	G9
E2	E2	G11
E4	E4	G104
E9	E9	
G9		
G104		

design Luigi Vaghi MN 689 Z

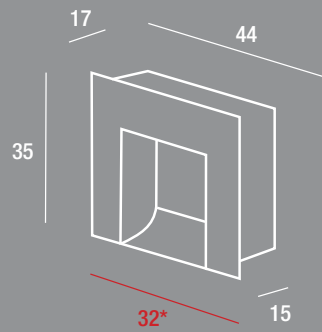

Applicazioni Applications	Eps Epoxy Coating	Galvaniche Galvanic
E1	E1	G9
E2	E2	G11
E4	E4	G104
E9	E9	
G9		
G11		
G104		

design Luigi Vaghi MN 689 Z

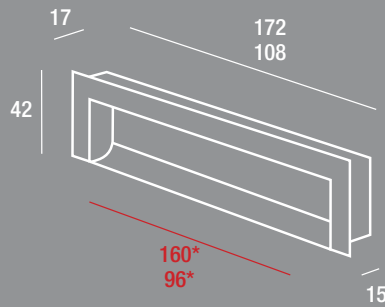

Applicazioni Applications	Eps Epoxy Coating	Galvaniche Galvanic
	E1	
	E2	
	E4	
	E9	

design Luigi Vaghi MN 704 Z

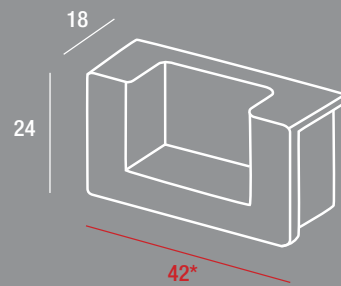

Applicazioni Applications	Eps Epoxy Coating	Galvaniche Galvanic
	E1	G9
	E2	G104
	E9	G171
	E4	

design **MN 803 Z**
Marelli e Molteni

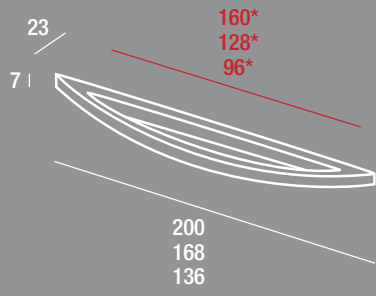

Applicazioni Applications	Eps Epoxy Coating	Galvaniche Galvanic
E1	E1	G104
E2	E2	G115
E9	E9	G150
G104		
G115		
G150		

design **MN 763 Z**
Marelli e Molteni

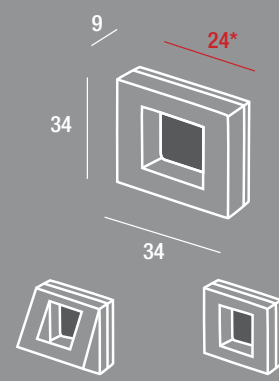

Applicazioni Applications	Eps Epoxy Coating	Galvaniche Galvanic
E1	E1	G104
E2	E2	G115
E9	E9	G150
G104		
G115		
G150		

design **MN 762 Z**
Marelli e Molteni

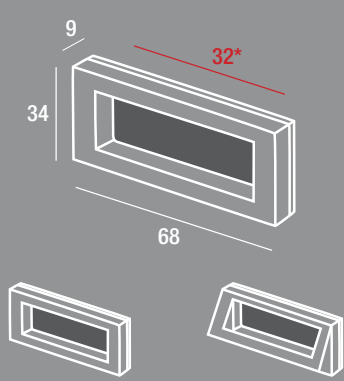

Applicazioni Applications	Eps Epoxy Coating	Galvaniche Galvanic
E1	E1	G104
E2	E2	G115
E9	E9	G150
G104		
G115		
G150		

design **MN 761 Z**
Marelli e Molteni

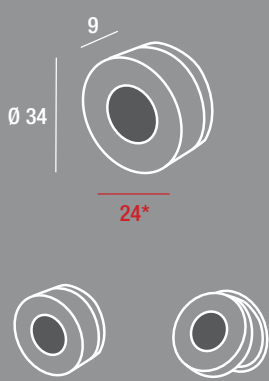



MN 895 Z design Marelli e Molteni



Galvaniche Galvanic	Eps Epoxy Coating	Applicazioni Applications
	E1	
	E2	
	E9	



MN 896 Z design Marelli e Molteni

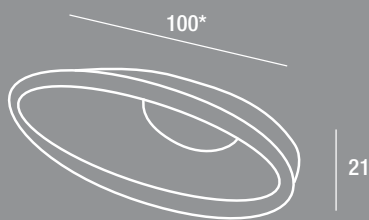

Galvaniche Galvanic	Eps Epoxy Coating	Applicazioni Applications
	E1	
	E2	
	E9	



MN 643 Z design Marelli e Molteni

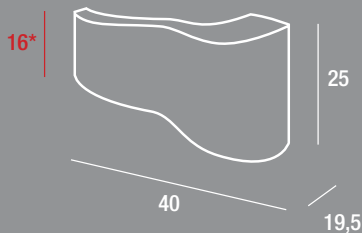

Galvaniche Galvanic	Eps Epoxy Coating	Applicazioni Applications
G104	E1	
G105	E2	
G107	E4	
G115	E9	
G140		



MN 642 Z design Marelli e Molteni

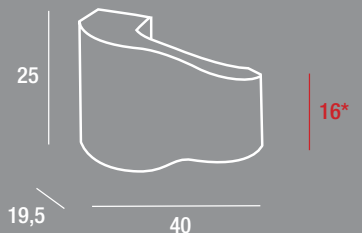

Galvaniche Galvanic	Eps Epoxy Coating	Applicazioni Applications
G104	E1	
G105	E2	
G107	E4	
G115	E9	
G140		



PO 271 Z

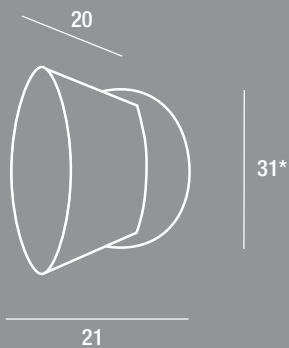

Galvaniche Galvanic	Eps Epoxy Coating	Applicazioni Applications
G104	E1	
G115	E2	
G140	E4	
	E9	



PO 297 Z



Galvaniche Galvanic	Eps Epoxy Coating	Applicazioni Applications
G101	E1	
G102	E2	
G105	E4	
G107	E9	
G113		
G115		
G140		



PO 430 Z design Marelli e Molteni

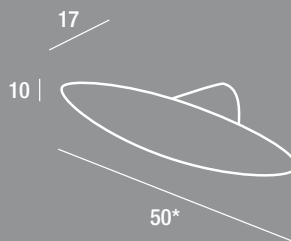

Galvaniche Galvanic	Eps Epoxy Coating	Applicazioni Applications
G9	E1	
G104	E2	
G115	E4	
	E9	



Izerwaren
order
numbers

Brass Pulls.

Many custom finishes possible



C6523 Swarovski Crystal

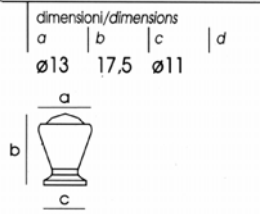

C7367 Carrara Marble

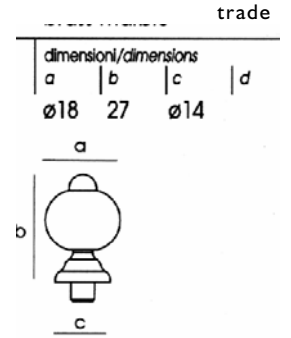

C6525 Swarovski Crystal

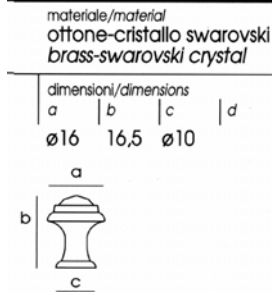

C7373 Carrara Marble

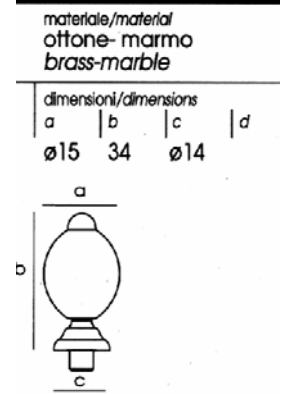

C7358 Carrara Marble

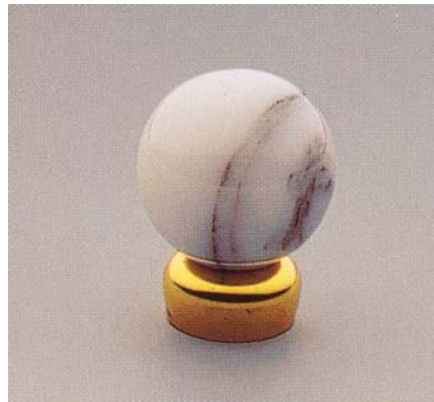
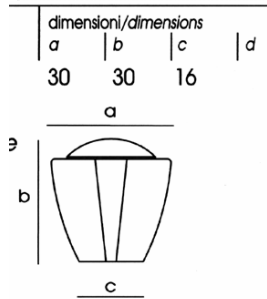

C7353 Carrara Marble

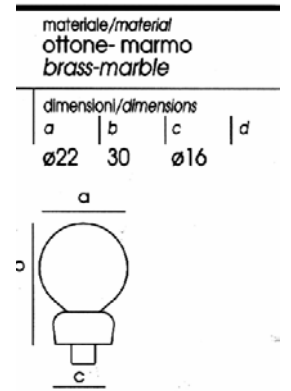

C7360 Carrara Marble

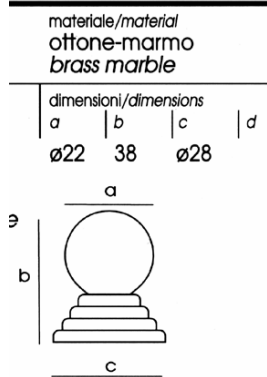

C7357 Carrara Marble

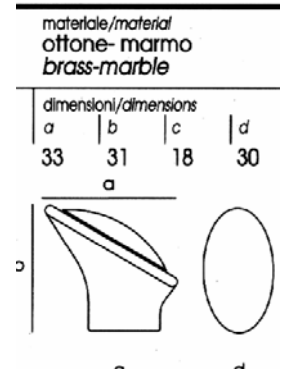

C7359 Carrara Marble



Cabinet Pulls, solid brass

Izerwaren
order
numbers

Brass Pulls.

Many custom finishes possible
trade



B0224

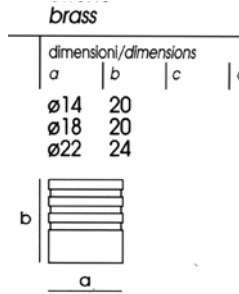

B0229

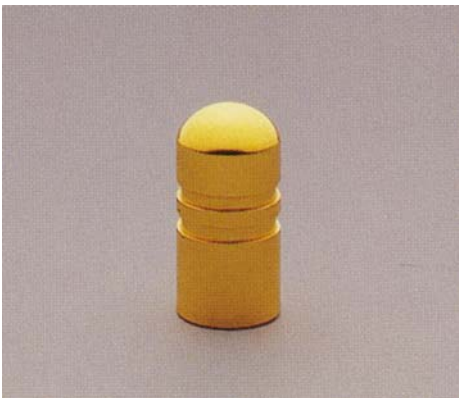
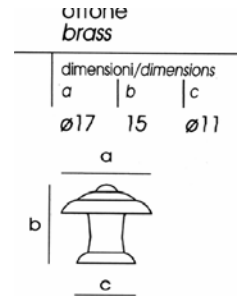

B0226

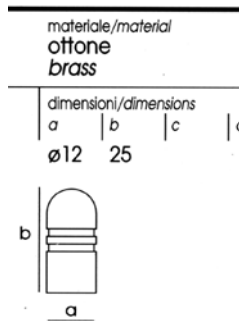

B0230

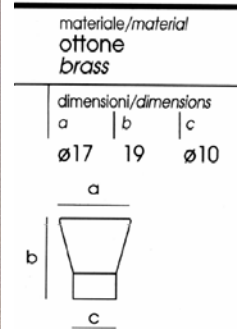

B0227

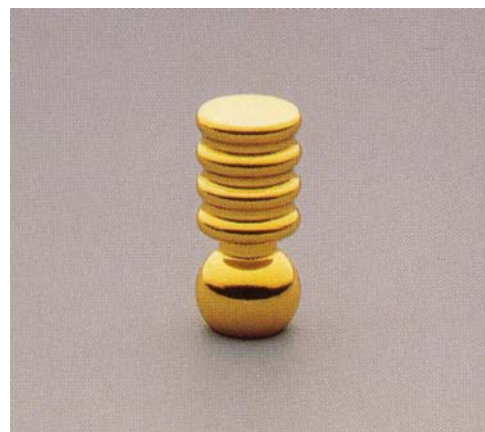
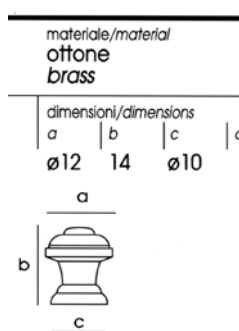

B0232

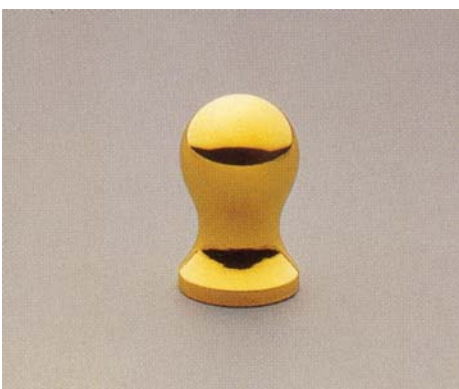
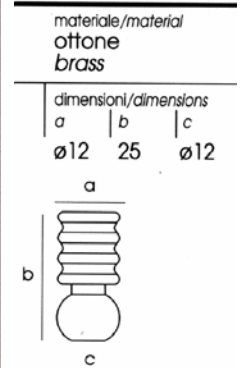

B0228

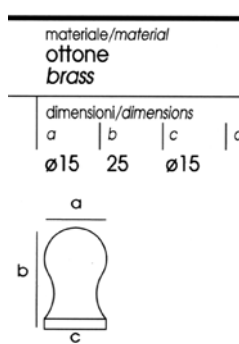

B0234

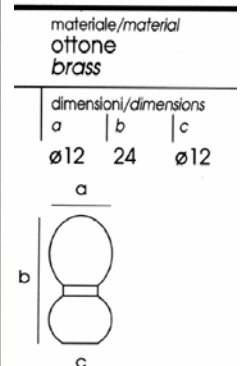



Cabinet Pulls, solid brass

Izerwaren
order
numbers

Brass Pulls.
Many custom finishes possible



B0236

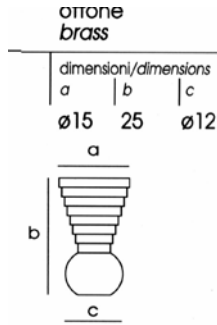

B0247

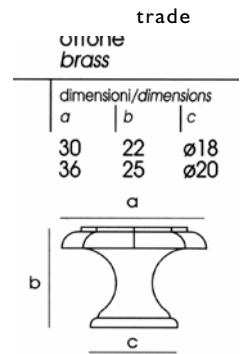

B0239

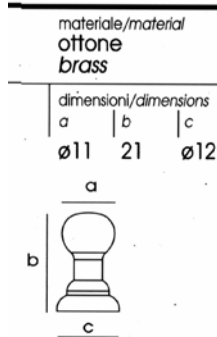

B0249

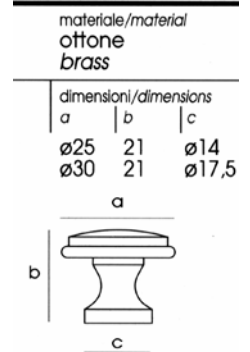

B0242

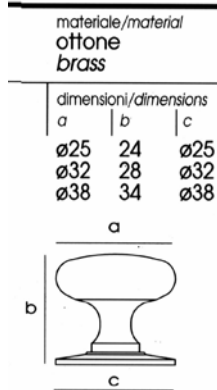

B0251

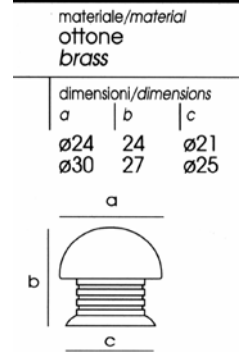

B0247

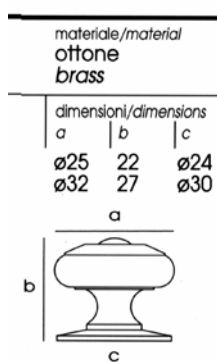

B0256

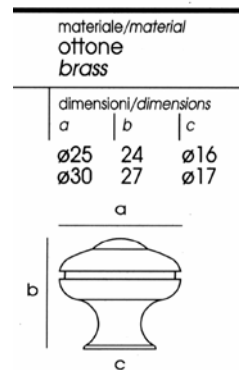



Cabinet Pulls, solid brass

Izerwaren
order
numbers

Brass Pulls.

Many custom finishes possible

trade

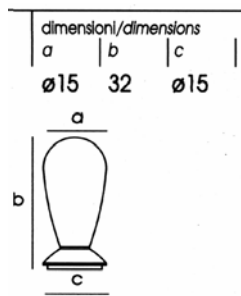
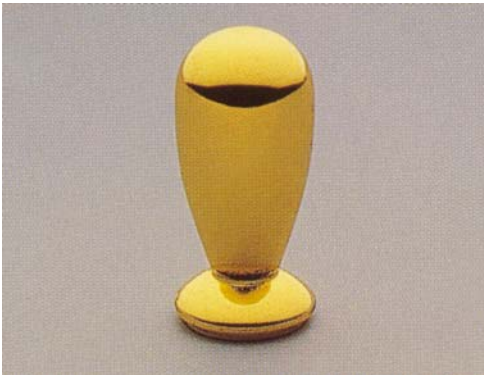

B0261

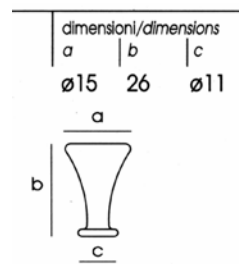

B0276

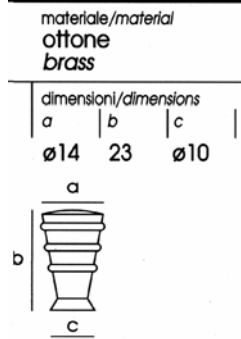

B0265

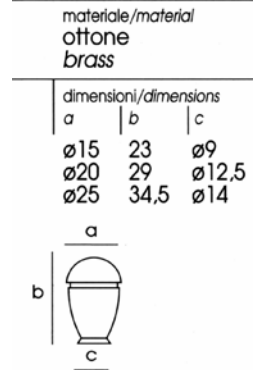

B0277

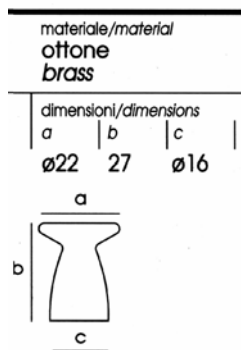

B0274

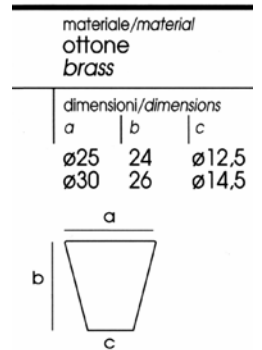
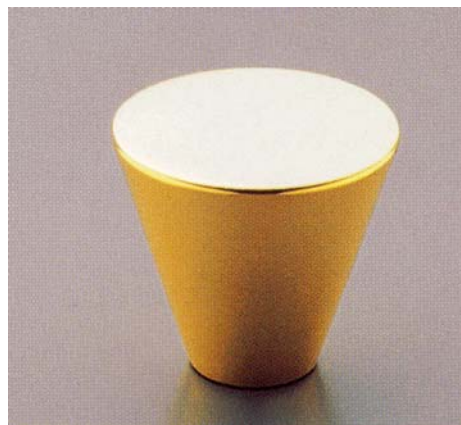

B0278

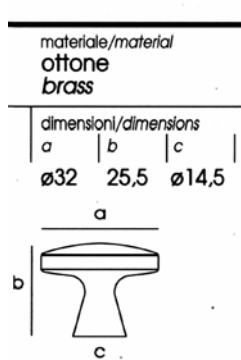

B0275

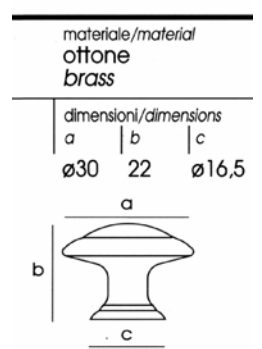

C3115



Izerwaren
order
numbers

Brass Pulls.

Many custom finishes possible

trade



C3121

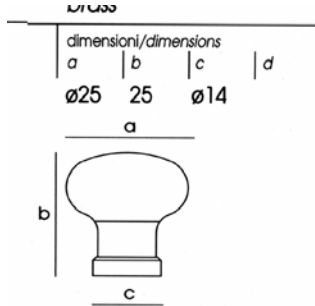

B0264



C0241

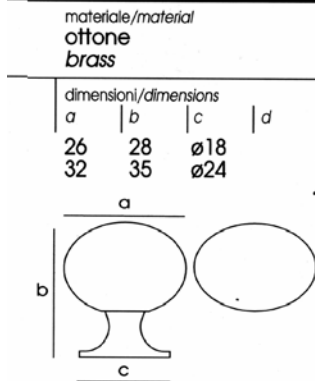

C0245

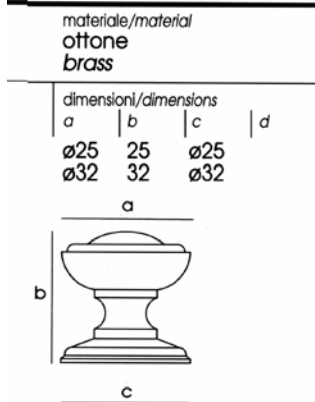

C0546

